



COMMERCIAL DIGITAL TWO-WAY RADIO

MOTOTRBO™ SL SERIES

SL300

DISPLAY PORTABLE RADIOS

USER GUIDE

Contents





Declaration of Conformity.....	5	Getting Started.....	13
Important Safety Information.....	7	How to Use This Guide.....	13
Software Version.....	8	What Your Dealer/System Administrator Can Tell You.....	13
Consignes de sécurité importantes.....	9	Preparing Your Radio for Use.....	14
Version logicielle.....	10	Charging the Battery.....	14
Computer Software Copyrights....	11	Attaching the Battery.....	14
Handling Precautions.....	12	Attaching the Antenna.....	15
		Attaching the Earpiece/Audio Accessory.....	16
		Powering Up the Radio.....	16
		Adjusting the Volume.....	17
		Identifying Radio Controls.....	18
		Radio Controls.....	18
		Programmable Buttons.....	18
		Assignable Radio Functions.....	19
		Assignable Settings or Utility Functions.....	19
		Accessing the Programmed Action List.....	20
		Push-To-Talk (PTT) Button.....	20
		On/Off/Information Button.....	21

Switching Between Conventional Analog and Digital Mode.....	22
--	----

Identifying Status Indicators.....24

LED Indicator.....	24
Audio Tones.....	25
Indicator Tones.....	25



Making and Receiving Calls26

Selecting a Zone.....	26
Selecting a Channel.....	26
Receiving and Responding to a Radio Call... 26	
Receiving and Responding to a Group Call.....	26
Receiving and Responding to a Private Call	27
Receiving an All Call 	28
Receiving and Responding to a Selective Call 	28
Making a Radio Call.....	29
Making a Group Call.....	29
Making a Private Call 	30
Making an All Call 	31
Making a Selective Call	31

Site Lock.....	31
Manual Site Roam.....	32
Talkaround.....	32
Monitoring Features.....	33
Monitoring a Channel.....	33
Permanent Monitor.....	33

Advanced Features.....34

Scan Lists.....	34
Scan.....	34
Starting and Stopping Scan.....	34
Responding to a Transmission During a Scan.....	35
Deleting a Nuisance Channel.....	35
Restoring a Nuisance Channel.....	35
Vote Scan 	36
Call Indicator Settings.....	36
Escalating Alarm Tone Volume.....	36
Call Alert Operation.....	36
Receiving and Responding to a Call Alert.....	36
Making a Call Alert with the One Touch Access Button.....	37
Emergency Operation.....	37
Sending an Emergency Alarm.....	38

Sending an Emergency Alarm with Call.....	38	Turning the Voice Announcement On or Off.....	45
Sending an Emergency Alarm with Voice to Follow	39	Authorized Accessories List.....	46
Reinitiating an Emergency Mode.....	40	Antennas.....	46
Exiting Emergency Mode After Sending the Emergency Alarm.....	40	Batteries.....	46
Privacy 	41	Carry Devices.....	46
Lone Worker.....	41	Chargers.....	46
Password Lock Features.....	42	Earbuds and Earpieces.....	46
Accessing the Radio from Password.....	42	Miscellaneous Accessories.....	46
Auto-Range Transponder System (ARTS) 	42	Batteries and Chargers Warranty.....	47
Utilities.....	43	The Workmanship Warranty.....	47
Setting the Squelch Level.....	43	The Capacity Warranty.....	47
Setting the Power Level.....	43	Limited Warranty.....	48
Turning the Voice Operating Transmission (VOX) Feature On or Off.....	43	MOTOROLA COMMUNICATION PRODUCTS.....	48
Turning the Radio Tones/Alerts On or Off.....	44	I. WHAT THIS WARRANTY COVERS AND FOR HOW LONG:.....	48
Checking the Battery Strength.....	44	II. GENERAL PROVISIONS:.....	49
Checking the RSSI Values.....	44	III. STATE LAW RIGHTS:.....	49
Adjusting the Display Brightness.....	45	IV. HOW TO GET WARRANTY SERVICE:.....	49
		V. WHAT THIS WARRANTY DOES NOT COVER:.....	50
		VI. PATENT AND SOFTWARE PROVISIONS:.....	50

VII. GOVERNING LAW:.....52

Declaration of Conformity

This declaration is applicable to your radio only if your radio is labeled with the FCC logo shown below.

Declaration of Conformity
Per FCC CFR 47 Part 2 Section 2.1077(a)

Responsible Party
Name: Motorola Solutions, Inc.
Address: 1303 East Algonquin Road, Schaumburg, IL 60196-1078, U.S.A.
Phone Number: 1-800-927-2744
Hereby declares that the product:
Model Name: SL300
conforms to the following regulations:
FCC Part 15, subpart B, section 15.107(a), 15.107(d) and section 15.109(a)

Class B Digital Device

As a personal computer peripheral, this device complies with Part 15 of the FCC Rules. This device complies with Industry Canada licence-exempt RSS standard(s). Operation is subject to the following two conditions:

- 1 This device may not cause harmful interference, and
- 2 This device must accept any interference received, including interference that may cause undesired operation.

Note:

This equipment has been tested and found to comply with the limits for a Class B digital device, pursuant to part 15 of the FCC Rules. These limits are designed to provide reasonable protection against harmful interference in a residential installation. This equipment generates, uses and can radiate radio frequency energy and, if not installed and used in accordance with the instructions, may cause harmful interference to radio communications. However, there is no guarantee that interference will not occur in a particular installation.

If this equipment does cause harmful interference to radio or television reception, which can be determined by turning the equipment off and on, the user is encouraged to try to correct the interference by one or more of the following measures:

- Reorient or relocate the receiving antenna.
- Increase the separation between the equipment and receiver.
- Connect the equipment into an outlet on a circuit different from that to which the receiver is connected.
- Consult the dealer or an experienced radio/TV technician for help.

Important Safety Information

ATTENTION!

This radio is restricted to Occupational use only.

Before using the radio, read the RF Energy Exposure and Product Safety Guide for Two-Way Radios which contains important operating instructions for safe usage and RF energy awareness and control for Compliance with applicable standards and Regulations.

For a list of Motorola-approved antennas and other accessories, visit the following website:

<http://www.motorolasolutions.com>

Any modification to this device, not expressly authorized by Motorola, may void the user's authority to operate this device.

Under Industry Canada regulations, this radio transmitter may only operate using an antenna of a type and maximum (or lesser) gain approved for the transmitter by Industry Canada. To reduce potential radio interference to other users, the antenna type and its gain should be so chosen that the equivalent

isotropically radiated power (e.i.r.p.) is not more than that necessary for successful communication.

This radio transmitter has been approved by Industry Canada to operate with Motorola-approved antenna with the maximum permissible gain and required antenna impedance for each antenna type indicated. Antenna types not included in this list, having a gain greater than the maximum gain indicated for that type, are strictly prohibited for use with this device.

Software Version

All the features described in the following sections are supported by the radio's software version **R01.00.25** or later.

Check with your dealer or system administrator for more details of all the features supported.

Consignes de sécurité importantes

ATTENTION!

Cette radio ne doit être utilisée qu'à des fins professionnelles. Avant d'utiliser la radio, lisez le guide Radios bidirectionnelles : exposition aux radiofréquences et sécurité du produit, qui contient d'importantes instructions de fonctionnement pour une utilisation sécuritaire et des informations sur l'exposition aux fréquences radioélectriques, dans le but d'assurer votre conformité aux normes et règlements en vigueur.

Visitez le site Web suivant pour obtenir la liste des antennes et des autres accessoires approuvés par Motorola :

<http://www.motorolasolutions.com>

Toute modification effectuée à cet appareil sans l'autorisation explicite de Motorola peut annuler l'autorisation d'utiliser cet appareil.

Selon la réglementation d'Industrie Canada, cet émetteur radio ne peut être utilisé qu'avec une antenne dont le type et le gain maximal (ou minimal) sont approuvés par Industrie Canada pour cet

émetteur. Afin de limiter les interférences radio pour les autres utilisateurs, le type et le gain de l'antenne doivent être choisis de façon à ce que la puissance isotrope rayonnée équivalente (P.I.R.E.) ne soit pas plus forte qu'il ne le faut pour établir la communication.

Cet émetteur radio a été approuvé par Industrie Canada pour utilisation avec une antenne approuvée par Motorola offrant le gain maximal autorisé et l'impédance requise pour le type d'antenne indiqué. Il est strictement interdit d'utiliser avec cet appareil tout type d'antenne ne figurant pas dans cette liste et présentant un gain supérieur au maximum indiqué pour le type.

Version logicielle

Toutes les fonctions décrites dans les sections suivantes sont prises en charge par la version **R01.00.25** ou les versions ultérieures du logiciel de la radio.

Pour obtenir davantage de renseignements à propos des fonctions prises en charge, adressez-vous à votre détaillant ou à votre administrateur de système.

Computer Software Copyrights

The Motorola products described in this manual may include copyrighted Motorola computer programs stored in semiconductor memories or other media. Laws in the United States and other countries preserve for Motorola certain exclusive rights for copyrighted computer programs including, but not limited to, the exclusive right to copy or reproduce in any form the copyrighted computer program. Accordingly, any copyrighted Motorola computer programs contained in the Motorola products described in this manual may not be copied, reproduced, modified, reverse-engineered, or distributed in any manner without the express written permission of Motorola. Furthermore, the purchase of Motorola products shall not be deemed to grant either directly or by implication, estoppel, or otherwise, any license under the copyrights, patents or patent applications of Motorola, except for the normal non-exclusive license to use that arises by operation of law in the sale of a product.

The AMBE+2™ voice coding Technology embodied in this product is protected by intellectual property rights

including patent rights, copyrights and trade secrets of Digital Voice Systems, Inc.

This voice coding Technology is licensed solely for use within this Communications Equipment. The user of this Technology is explicitly prohibited from attempting to decompile, reverse engineer, or disassemble the Object Code, or in any other way convert the Object Code into a human-readable form.

U.S. Pat. Nos. #5,870,405, #5,826,222, #5,754,974, #5,701,390, #5,715,365, #5,649,050, #5,630,011, #5,581,656, #5,517,511, #5,491,772, #5,247,579, #5,226,084 and #5,195,166.

Handling Precautions

The MOTOTRBO Series Digital Portable radio meets IP54 specifications, allowing the radio to withstand adverse field conditions such as being exposed to water or dust.

- Keep your radio clean and exposure to water should be avoided to help ensure proper functionality and performance.
- To clean the exterior surfaces of the radio, use a diluted solution of mild dishwashing detergent and fresh water (i.e. one teaspoon of detergent to one gallon of water).
- These surfaces should be cleaned whenever a periodic visual inspection reveals the presence of smudges, grease, and/or grime.



Caution: The effects of certain chemicals and their vapors can have harmful results on certain plastics. Avoid using aerosol sprays, tuner cleaners and other chemicals.

Getting Started

How to Use This Guide

This User Guide covers the basic operation of the MOTOTRBO Portables.

However, your dealer or system administrator may have customized your radio for your specific needs. Check with your dealer or system administrator for more information.

Throughout this publication, the icons described next are used to indicate features supported in either the conventional Analog mode or conventional Digital mode:



Indicates a conventional **Analog Mode-Only** feature.



Indicates a conventional **Digital Mode-Only** feature.

For features that are available in **both** conventional Analog and Digital modes, **no** icon is shown.

What Your Dealer/System Administrator Can Tell You

You can consult your dealer or system administrator about the following:

- Is your radio programmed with any preset conventional channels?
- Which buttons have been programmed to access other features?
- What optional accessories may suit your needs?
- What are the best radio usage practices for effective communication?
- What maintenance procedures will help promote longer radio life?

Preparing Your Radio for Use

Charging the Battery

Your radio is powered by a Lithium-Ion (Li-Ion) battery. To avoid damage and to ensure compliance with warranty terms, charge the battery using a Motorola charger *exactly* as described in the charger user guide. All chargers can charge only Motorola authorized batteries. Other batteries may not charge. It is recommended your radio remains powered off while charging.

Charge a new battery 14 to 16 hours before initial use for best performance. Prior to charging a battery with the radio, it is recommended to turn the radio off. Batteries charge best at room temperature.

The battery charging animation will be displayed and the LED lights up solid red until the user unplugs the USB cable.

Attaching the Battery

- 1 Align the battery contacts with the contacts inside the battery compartment. Insert the contact side of the battery first. Gently push the battery into place.

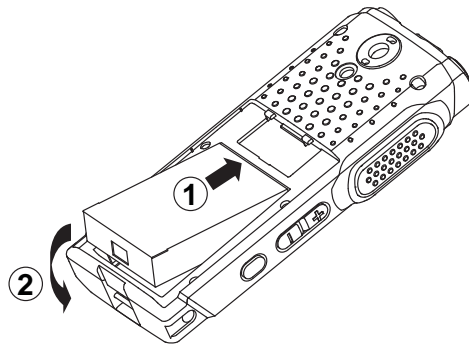

- 2 To attach battery cover, align it in place and slide the battery latch until it snaps into place. Slide battery latch into lock position.

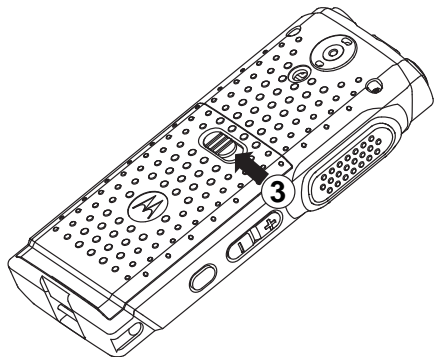
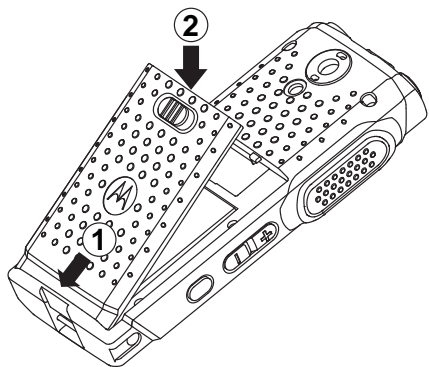

Attaching the Antenna



Caution: If antenna needs to be replaced, ensure that only MOTOTRBO antennas are used. Neglecting this will damage your radio. See [Antennas](#) on page 46 for a list of available antennas.

- 1 With the radio turned off, set the antenna in its receptacle and turn clockwise.

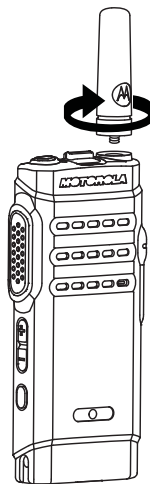

- To remove the antenna, turn the antenna counterclockwise.

Lift the flap of the Audio Jack cover. Align the indicators (A) on both the connector and housing, then push until it fits in properly.

Attaching the Earpiece/Audio Accessory

The audio jack (A) is located on the antenna side of the radio. It is used to connect accessories to the radio.

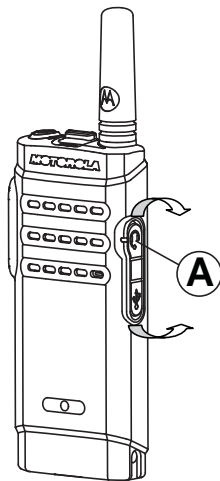

Powering Up the Radio

Short press the **On/Off/Information Button** (A). You see a power on animation.

The LED lights up solid green.

Note: Long press the **On/Off/Information Button** to power up the radio when the radio is charging.

*To turn off the radio, long press the **On/Off/Information Button**.*

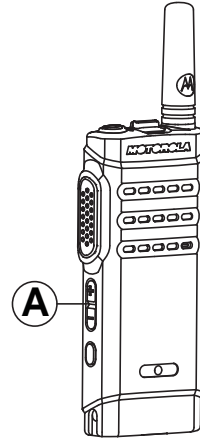
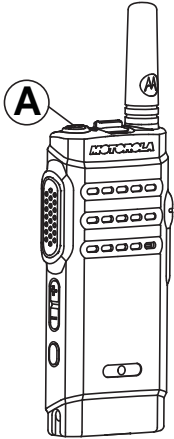

Adjusting the Volume

To increase the volume, push the (+) **Volume Button** (A) up.

To decrease the volume, push the (-) **Volume Button** down.

Note: Your radio can be programmed to have a minimum volume offset where the volume level cannot be lowered past the programmed minimum volume. Check with your dealer or system administrator for more information.

Identifying Radio Controls

Radio Controls

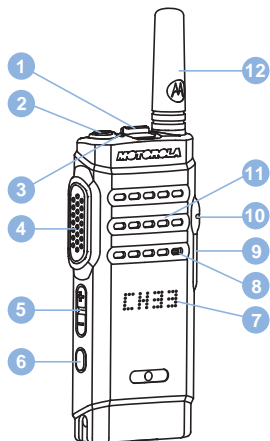

- 1 Channel Rocker
- 2 On/Off/Information Button
- 3 LED Indicator

- 4 Push-to-Talk (PTT) Button
- 5 Volume Button
- 6 Side Button 1^[1]
- 7 Display
- 8 Microphone
- 9 USB Connector
- 10 Accessory Connector
- 11 Speaker
- 12 Antenna

Programmable Buttons

Your dealer can program the programmable buttons as shortcuts to radio functions depending on the duration of a button press:

- Short press – Pressing and releasing rapidly.
- Long press – Pressing and holding for the programmed duration.
- Hold down – Keeping the button pressed.

Note: The programmed duration of a button press is applicable for all assignable radio/utility functions or settings. See [Emergency Operation](#) on page 37 for

more information on the programmed duration of the **Emergency** button.

Assignable Radio Functions

Actions – A programmable button to access a CPS programmable action list.

Emergency On/Off – Depending on the programming, initiates or cancels an emergency.

Manual Site Roam – Starts the manual site search.

Mic AGC On/Off – Toggles the internal microphone automatic gain control (AGC) on or off.

Monitor – Monitors a selected channel for activity.

Nuisance Channel Delete – Temporarily removes an unwanted channel, except for the Selected Channel, from the scan list. The Selected Channel refers to the user's selected zone/channel combination from which scan is initiated.

One Touch Access – Directly initiates a predefined channel, a Private or Group Call, or a Call Alert.

Permanent Monitor – Monitors a selected channel for all radio traffic until function is disabled.

Privacy  – Toggles privacy on or off.

Repeater/Talkaround – Toggles between using a repeater and communicating directly with another radio.

Scan – Toggles scan on or off.

Site Lock On/Off – When toggled on, the radio searches the current site only. When toggled off, the radio searches other sites in addition to the current site.

Voice Announcement On/Off – Toggles voice announcement on or off.

Voice Operating Transmission (VOX) – Toggles VOX on or off.

Zone Toggle – Allows radio user to toggle between Zone 1 and Zone 2.

Assignable Settings or Utility Functions

All Tones/Alerts – Toggles all tones and alerts on or off.

Power Level – Toggles transmit power level between high and low.

Squelch  – Toggles squelch level between tight and normal.

Accessing the Programmed Action List

You can access the CPS programmable action list by using the programmed **Actions** button.

- 1 Press the programmed **Actions** button.
The display shows the first item in the action list, a tone sounds, and the radio plays the item announcement voice message.

- 2 Press the programmed **Actions** button again to navigate to the next item in the action list.
The display shows the next item in the action list, a tone sounds, and the radio plays the item announcement voice message.

- 3 Press the **Volume Button** up or down to toggle on or off, or change the status of the item.
The display shows the item status, a tone sounds, and the radio plays the item announcement voice message.

Push-To-Talk (PTT) Button

The **PTT** button on the side of the radio (A) serves two basic purposes:

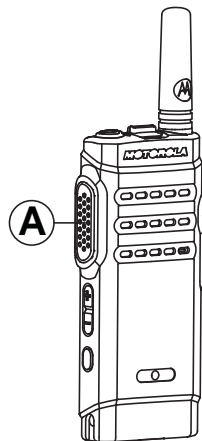



- While a call is in progress, the **PTT** button allows the radio to transmit to other radios in the call.

Press and hold down **PTT** button to talk. Release the **PTT** button to listen.

The microphone is activated when the **PTT** button is pressed.
- While a call is not in progress, the **PTT** button is used to make a new call (see [Making a Radio Call](#) on page 29).

If the Talk Permit Tone or the **PTT Sidetone**  is enabled, wait until the short alert tone ends before talking.

 During a call, if the Channel Free Indication feature is enabled on your radio (programmed by your dealer), you will hear a short alert tone the moment the target radio (the radio that is receiving your call) releases the **PTT** button, indicating the channel is free for you to respond.

 You will also hear a continuous talk prohibit tone, if your call is interrupted, indicating that you should release the **PTT** button, for example when the radio receives an Emergency Call.

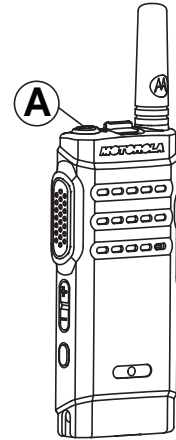

On/Off/Information Button

The **On/Off/Information** button at the top of the radio () serves four basic purposes:

- The **On/Off/Information** button is used to power the radio on or off.
See [Powering Up the Radio](#) on page 16 for details on powering up the radio.
- The **On/Off/Information** button is used to check the battery strength when the radio is powered off while charging.

Short press the **On/Off/Information** button when the radio is powered off while charging. The radio plays the battery strength announcement voice message, shows the LED indicator of the battery

strength, and displays the battery charging icon and battery strength level.

See [LED Indicator](#) on page 24 for more information.

- The **On/Off/Information** button is used to check the Received Signal Strength Indicator (RSSI) signal strength and battery strength when the radio is powered on, charging or not.

Short press the **On/Off/Information** button when the radio is powered on. The radio plays the battery strength announcement voice message, shows the LED indicator of the battery strength, and displays the RSSI icon and battery strength level.

See [LED Indicator](#) on page 24 for more information.

- The **On/Off/Information** button is used to check the radio name when the radio is powered on.

Short press the **On/Off/Information** button twice when the radio is powered on. The radio displays the radio name.

Switching Between Conventional Analog and Digital Mode

Each channel in your radio can be configured as a conventional analog or conventional digital channel. Use the **Channel Rocker** (A) to switch between an analog or a digital channel.

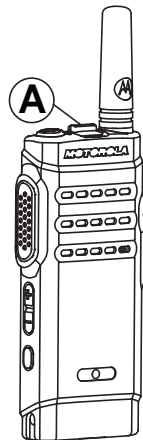

When switching from digital to analog mode, certain features are unavailable.

Your radio also has features available in both analog and digital mode. However, the minor differences in the way each feature works does **not** affect the performance of your radio.

Note: Your radio also switches between digital and analog modes during a dual mode scan (see [Scan](#) on page 34).

Identifying Status Indicators

LED Indicator

The LED indicator (A) shows the operational status of your radio.

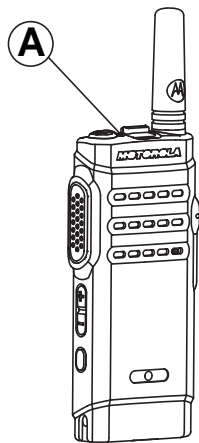

Solid red

Radio is charging.

Blinking red

Radio is transmitting at low battery condition, receiving

an emergency transmission, has failed the self-test upon powering up, has charging errors, or has moved out of range if radio is configured with Auto-Range Transponder System. Also indicates low battery charge when the **On/Off/Information** button is pressed.

Solid yellow

Radio is monitoring a conventional channel. Also indicates fair battery charge when the **On/Off/Information** button is pressed.



Blinking yellow

Radio is scanning for activity or receiving a Call Alert, or the flexible receive list is enabled.

Solid green



Radio is powering up, sending a Call Alert or an emergency transmission,

	or transmitting. Also indicates full charge of the battery when the programmable On/Off/Information button is pressed.
Blinking green	Radio is receiving a call or data, or detecting activity over the air.

Repetitive Tone 	A single tone that repeats itself until it is terminated by the user.
Momentary Tone 	Sounds only once for a short period of time defined by the radio.



Indicator Tones

High pitched tone	<input type="checkbox"/>	Low pitched tone	<input checked="" type="checkbox"/>
-------------------	--------------------------	------------------	-------------------------------------

	Positive Indicator Tone
	Negative Indicator Tone

Audio Tones

Audio tones provide you with audible indications of the status, or response to data received on the radio.

Continuous Tone 	A monotone sound. Sounds continuously until termination.
Periodic Tone 	Sounds periodically depending on the duration set by the radio. Tone starts, stops, and repeats itself.

Making and Receiving Calls

Selecting a Zone

A zone is a group of channels. Your radio supports up to 99 channels and 2 zones.

Press the programmed **Zone Toggle** button to select Zone 1 or Zone 2.

Selecting a Channel

Transmissions are sent and received on a channel. Depending on your radio's configuration, each channel may have been programmed differently to support different groups of users or supplied with different features.

The display shows the current channel and plays the channel announcement voice message when you push the **Channel Rocker**.

When the display is showing the current channel and you push the **Channel Rocker** to the target channel, the display shows the target channel and plays the channel announcement voice message.

Push the **Channel Rocker** to select the channel.

Receiving and Responding to a Radio Call

Once the channel, subscriber ID, or group ID is set, you can proceed to receive and respond to calls.

The LED lights up solid green while the radio is transmitting and blinks green when the radio is receiving.

Note: To unscramble a privacy-enabled call, your radio must have the same Privacy Key, OR the same Key Value and Key ID (programmed by your dealer), as the transmitting radio (the radio you are receiving the call from).

Receiving and Responding to a Group Call

To receive a call from a group of users, your radio must be configured as part of that group.

The LED blinks green. Your radio unmutes and the incoming call sounds through the radio's speaker.

- 1 Hold the radio vertically 1 to 2 inches (2.5 to 5.0 cm) from your mouth.

-  If the Channel Free Indication feature is enabled, you hear a short alert tone the moment the transmitting radio releases the **PTT** button, indicating the channel is free for you to respond. Press the **PTT** button to respond.

The LED lights up solid green.

- 2 Wait for one of the following tones to finish (if enabled), and speak clearly into the microphone.
 - The Talk Permit Tone.
 - The **PTT** Sidetone. 

- 3 Release the **PTT** button to listen.

If there is no voice activity for a predetermined period of time, the call ends.

See [Making a Group Call](#) on page 29 for details on making a Group Call.

Receiving and Responding to a Private Call

A Private Call is a call from an individual radio to another individual radio.

When you receive a Private Call, the LED blinks green. Your radio unmutes and the incoming call sounds through the radio's speaker.

- 1 Hold the radio vertically 1 to 2 inches (2.5 to 5.0 cm) from your mouth.
 -  If the Channel Free Indication feature is enabled, you hear a short alert tone the moment the transmitting radio releases the **PTT** button, indicating the channel is free for you to respond. Press the **PTT** button to respond.

The LED lights up solid green.

- 2 Wait for the Talk Permit Tone to finish (if enabled), and speak clearly into the microphone.
- 3 Release the **PTT** button to listen.

If there is no voice activity for a predetermined period of time, the call ends.

See [Making a Private Call](#) on page 30 for details on making a Private Call.

Receiving an All Call

An All Call is a call from an individual radio to every radio on the channel. It is used to make important announcements requiring the user's full attention.

When you receive an All Call, a tone sounds and the LED blinks green.

Your radio unmutes and the incoming call sounds through the radio speaker.

An All Call does not wait for a predetermined period of time before ending.

 If the Channel Free Indication feature is enabled, you will hear a short alert tone the moment the transmitting radio releases the **PTT** button, indicating the channel is now available for use.

You cannot respond to an All Call.

Note: The radio stops receiving the All Call if you switch to a different channel while receiving the call. During an All Call, you will **not** be able to use any programmed button functions until the call ends.

Receiving and Responding to a Selective Call

A Selective Call is a call from an individual radio to another individual radio. It is a Private Call on an analog system.

When you receive a Selective Call, the LED blinks green. Your radio unmutes and the incoming call sounds through the radio's speaker.

- 1 Hold the radio vertically 1 to 2 inches (2.5 to 5.0 cm) from your mouth.

- 2 Press the **PTT** button to respond to the call. The LED lights up solid green.

- 3 Wait for the Talk Permit Tone to finish (if enabled), and speak clearly into the microphone.

- 4 Release the **PTT** button to listen.

If there is no voice activity for a predetermined period of time, the call ends.

See [Making a Private Call](#) on page 30 for details on making a Private Call.

Making a Radio Call

You can select a channel by using:

- **Channel Rocker**
- A programmed **One Touch Access** button 

Note: Your radio must have the Privacy feature enabled on the channel to send a privacy-enabled transmission. Only target radios with the same Privacy Key as your radio will be able to unscramble the transmission.

Making a Group Call

To make a call to a group of users, your radio must be configured as part of that group.

- 1 Do one of the following.
 - Select the channel with the active group alias or ID. See [Selecting a Channel](#) on page 26.
 - Press the programmed **One Touch Access** button.
-
- 2 Hold the radio vertically 1 to 2 inches (2.5 to 5.0 cm) from your mouth.
-
- 3 Press the **PTT** button to make the call.

The LED lights up solid green. The display shows the group call alias.

- 4 Wait for one of the following tones to finish (if enabled), and speak clearly into the microphone.
 - The Talk Permit Tone.
 - The **PTT** Sidetone. 
-
- 5 Wait for the Talk Permit Tone to finish (if enabled), and speak clearly into the microphone.
-
- 6 Release the **PTT** button to listen.

When the target radio responds, the LED blinks green. You see the transmitting radio alias or ID on your display.
-
- 7  If the Channel Free Indication feature is enabled, you hear a short alert tone the moment the transmitting radio releases the **PTT** button, indicating the channel is free for you to respond. Press the **PTT** button to respond.

If there is no voice activity for a predetermined period of time, the call ends. Radio returns to the screen you were on prior to initiating the call.
-

Making a Private Call

While you can receive and/or respond to a Private Call initiated by an authorized individual radio, your radio must be programmed for you to initiate a Private Call.

There are two types of Private Calls. The first type, where a radio presence check is performed prior to setting up the call, while the other sets up the call immediately.

Only **one** of these call types can be programmed to your radio by your dealer.

You will hear a negative indicator tone, when you make a Private Call via the **One Touch Access** button, if this feature is not enabled.

Use the Call Alert features to contact an individual radio. See [Call Alert Operation](#) on page 36 for more information.

- 1 Do one of the following.
 - Select the channel with the active subscriber alias or ID. See [Selecting a Channel](#) on page 26.

- Press the programmed **One Touch Access** button.
-

- 2 Hold the radio vertically 1 to 2 inches (2.5 to 5.0 cm) from your mouth.

- 3 Press the **PTT** button to make the call. The LED lights up solid green. The display shows the subscriber alias.

- 4 Wait for the Talk Permit Tone to finish (if enabled), and speak clearly into the microphone.

- 5 Release the **PTT** button to listen. When the target radio responds, the LED blinks green.

- 6  If the Channel Free Indication feature is enabled, you hear a short alert tone the moment the transmitting radio releases the **PTT** button, indicating the channel is free for you to respond. Press the **PTT** button to respond.

If there is no voice activity for a predetermined period of time, the call ends. You hear a short tone.

Making an All Call

This feature allows you to transmit to all users on the channel. Your radio must be programmed to allow you to use this feature.

Users on the channel cannot respond to an All Call.

- 1 Select the channel with the active All Call group alias or ID. See [Selecting a Channel](#) on page 26.

- 2 Hold the radio vertically 1 to 2 inches (2.5 to 5.0 cm) from your mouth.

- 3 Press the **PTT** button to make the call.

Making a Selective Call

Just like a Private Call, while you can receive and/or respond to a Selective Call initiated by an authorized individual radio, your radio must be programmed for you to initiate a Selective Call.

- 1 Select the channel with the active subscriber alias or ID. See [Selecting a Channel](#) on page 26.

- 2 Hold the radio vertically 1 to 2 inches (2.5 to 5.0 cm) from your mouth.

- 3 Press the **PTT** button to make the call.
The LED lights up solid green.

- 4 Wait for one of the following tones to finish (if enabled), and speak clearly into the microphone.
 - The Talk Permit Tone.
 - The **PTT** Sidetone. 

- 5 Release the **PTT** button to listen.
When the target radio responds, the LED blinks green.

 If the Channel Free Indication feature is enabled, you hear a short alert tone the moment the transmitting radio releases the **PTT** button, indicating the channel is free for you to respond. Press the **PTT** button to respond.

If there is no voice activity for a predetermined period of time, the call ends.

Site Lock

A site provides coverage for a specific area.

When toggled on, the radio searches the current site only. When toggled off, the radio searches other sites in addition to the current site.

Press the programmed **Site Lock** button.

When toggled on, the display shows the Site Lock icon and positive mini notice, and the radio plays the Site Lock announcement voice message.

When toggled off, the display shows the Site Lock icon and negative mini notice, and the radio plays the Site Lock announcement voice message.

Note: This feature is limited to radios with this function enabled. Check with your dealer or system administrator for more information.

Manual Site Roam

Press the programmed **Manual Site Roam** button. The display shows `SITE`, and the radio plays the Manual Site Roam announcement voice message.

If a new site is found, a tone sounds, and the display shows positive mini notice and the channel of the new site.

If there is no available site within range, a tone sounds, and the display shows negative mini notice and the current channel.

If a new site is within range, but the radio is unable to connect to it, a tone sounds, and the display shows negative mini notice and the current channel.

Note: This feature is limited to radios with this function enabled. Check with your dealer or system administrator for more information.

Talkaround

You can continue to communicate when your repeater is not operating, or when your radio is out of the repeater's range but within talking range of other radios.

This is called "talkaround".

The Talkaround setting is retained even after powering down.

Press the programmed **Repeater/Talkaround** button.

You hear ...	Indicating ...
Positive Indicator Tone	Radio is in Talkaround mode.
Negative Indicator Tone	Radio is in Repeater mode.

Monitoring Features

Monitoring a Channel

Use the Monitor feature to make sure a channel is clear before transmitting.

- 1 Press and hold the programmed **Monitor** button and listen for activity.

The LED lights up solid yellow. You hear radio activity or total silence, depending on how your radio is programmed. This indicates that the channel is in use.

- 2  Wait until you hear “white noise”. This indicates that the channel is free.

- 3 Press the **PTT** button to talk and release it to listen.

Permanent Monitor

Use the Permanent Monitor feature to continuously monitor a selected channel for activity.

- 1 Press the programmed **Permanent Monitor** button to activate permanent monitoring of the channel.
Radio sounds an alert tone, the LED lights up solid yellow.
- 2 Press the programmed **Permanent Monitor** button to exit Permanent Monitor mode.
Radio sounds an alert tone, the LED turns off.

Advanced Features

Scan Lists

Scan lists are created and assigned to individual channels/groups. Your radio scans for voice activity by cycling through the channel/group sequence specified in the scan list for the current channel/group.

Your radio can support up to 64 scan lists, with a maximum of 16 members in a list. Each scan list supports a mixture of both analog and digital entries.

You can add, delete, or prioritize channels by editing a scan list.

Scan

When you start a scan, your radio cycles through the programmed scan list for the current channel looking for voice activity.

The LED blinks yellow and you see the Scan icon on the display.

During a dual mode scan, if you are on a digital channel, and your radio locks onto an analog

channel, it automatically switches from digital mode to analog mode for the duration of the call. This is also true for the reverse.

There are two ways of initiating scan:

- **Main Channel Scan (Manual):** Your radio scans all the channels/groups in your scan list. On entering scan, your radio may – depending on the settings – automatically start on the last scanned “active” channel/group or on the channel where scan was initiated.
- **Auto Scan (Automatic):** Your radio automatically starts scanning when you select a channel/group that has Auto Scan enabled.

Starting and Stopping Scan

Do one of the following.

- Press the programmed **Scan** button.
- Use the **Channel Rocker** to select a channel programmed with Auto Scan enabled.

The LED blinks yellow and you hear a positive indicator tone, when Scan is enabled.

The LED turns off and you hear a negative indicator tone, when Scan is disabled.

Responding to a Transmission During a Scan

During scanning, your radio stops on a channel/group where activity is detected. The radio stays on that channel for a programmed time period known as “hang time”.

- 1 Hold the radio vertically 1 to 2 inches (2.5 to 5.0 cm) from your mouth.

 If the Channel Free Indication feature is enabled, you hear a short alert tone the moment the transmitting radio releases the **PTT** button, indicating the channel is free for you to respond.

- 2 Press the **PTT** button during hang time. The LED lights up solid green.
-

- 3 Wait for one of the following tones to finish (if enabled), and speak clearly into the microphone.

- The Talk Permit Tone.
 - The **PTT** Sidetone. 
-

- 4 Release the **PTT** button to listen.

If you do not respond within the hang time, the radio returns to scanning other channels/groups.

Deleting a Nuisance Channel

If a channel continually generates unwanted calls or noise (termed a “nuisance” channel), you can temporarily remove the unwanted channel from the scan list.

This capability does not apply to the channel designated as the Selected Channel.

Deleting a “nuisance” channel is **only** possible through the programmed **Nuisance Channel Delete** button. This feature is **not** accessible through the menu.

- 1 When your radio “locks on to” an unwanted or nuisance channel, press the programmed **Nuisance Channel Delete** button until you hear a tone.
-

- 2 Release the **Nuisance Channel Delete** button. The nuisance channel is deleted.
-

Restoring a Nuisance Channel

To restore the deleted nuisance channel, do one of the following:

- Turn the radio off and then power it on again.

- Stop and restart a scan via the programmed **Scan** button.
- Change the channel via the **Channel Rocker**.

Vote Scan

Vote Scan provides you with wide area coverage in areas where there are multiple base stations transmitting identical information on different analog channels.

Your radio scans analog channels of multiple base stations and performs a voting process to select the strongest received signal. Once that is established, your radio unmutes to transmissions from that base station.

The LED blinks yellow during the Vote Scan operation.

To respond to a transmission during a Vote Scan, follow the same procedures as [Responding to a Transmission During a Scan](#) on page 35.

Call Indicator Settings

You can turn on or off the ringing tones for a received Private Call (see [Turning the Radio Tones/Alerts On or Off](#) on page 44).

Escalating Alarm Tone Volume

You can program your radio to continually alert you when a radio call remains unanswered. This is done by automatically increasing the alarm tone volume over time. This feature is known as Escalart.

Call Alert Operation

Call Alert paging enables you to alert a specific radio user to call you back when they are able to do so.

This feature is accessible via a programmed **One Touch Access** button.

Receiving and Responding to a Call Alert

When you receive a Call Alert page, you see ALERT with the alias or ID of the calling radio on the display, hear a repetitive tone and the LED blinks yellow.

Press the **PTT** button within four (4) seconds of receiving a Call Alert page to respond to the Private Call.

Making a Call Alert with the One Touch Access Button

Press the programmed **One Touch Access** button to make a Call Alert to the predefined alias or ID.

The display shows **ALERT**.

The LED lights up solid green when your radio is sending the Call Alert.

If the Call Alert acknowledgement is received, a tone sounds and the display shows positive mini notice.

If the Call Alert acknowledgement is not received, a tone sounds and the display shows negative mini notice.

Emergency Operation

An Emergency Alarm is used to indicate a critical situation. You are able to initiate an Emergency at any time even when there is activity on the current channel.

Your dealer can set the duration of a button press for the programmed **Emergency** button, except for long press, which is similar with all other buttons:

- Short press – Between 0.05 seconds and 0.75 seconds
- Long press – Between 1.00 second and 3.75 seconds

The **Emergency** button is assigned with the Emergency On/Off feature. Check with your dealer for the assigned operation of the **Emergency** button.

Note: If the short press for the **Emergency** button is assigned to turn on the Emergency mode, then the long press for the **Emergency** button is assigned to exit the Emergency mode.

If the long press for the **Emergency** button is assigned to turn on the Emergency mode, then the short press for the **Emergency** button is assigned to exit the Emergency mode.

Your radio supports **three** Emergency Alarms:

- Emergency Alarm
- Emergency Alarm with Call
- Emergency Alarm with Voice to Follow

Note: Only **ONE** of the Emergency Alarms above can be assigned to the programmed **Emergency** button.

In addition, each alarm has the following types:

- **Regular** – Radio transmits an alarm signal and shows audio and/or visual indicators.
- **Silent** – Radio transmits an alarm signal without any audio or visual indicators. Radio receives calls without any sound through the radio's speaker, until you press the **PTT** button to initiate the call.
- **Silent with Voice** – Radio transmits an alarm signal without any audio or visual indicators, but allow incoming calls to sound through the radio's speaker.

Sending an Emergency Alarm

This feature allows you to send an Emergency Alarm, a non-voice signal, which triggers an alert indication on a group of radios.

If your radio is set to Silent, it does not display any audio or visual indicators during Emergency mode.

Press the programmed **Emergency On** button.
The display shows **ALRM**.

When an Emergency Alarm acknowledgement is received, the Emergency tone sounds and the LED blinks green.

If your radio does not receive an Emergency Alarm acknowledgement, and after all retries have been exhausted, a tone sounds.

Radio exits the Emergency Alarm mode.

Sending an Emergency Alarm with Call

This feature allows you to send an Emergency Alarm to a group of radios. Upon acknowledgement by a radio within the group, the group of radios can communicate over a programmed Emergency channel.

If your radio is set to Silent, it does not display any audio or visual indicators during Emergency mode, or allow any received calls to sound through the radio's speaker, until you press the **PTT** button to initiate the call.

If your radio is set to Silent with Voice, it does not display any audio or visual indicators during Emergency mode, but allow incoming calls to sound through the radio's speaker. The indicators only

appear once you press the **PTT** button to initiate, or respond to, the call.

- 1 Press the programmed **Emergency On** button.

The LED lights up solid green.

When an Emergency Alarm acknowledgement is received, the Emergency tone sounds and the LED blinks green.

- 2 Hold the radio vertically 1 to 2 inches (2.5 to 5.0 cm) from your mouth.
-

- 3 Press **PTT** button to make the call.
The LED lights up solid green.
-

- 4 Release the **PTT** button to listen.
 If the Channel Free Indication feature is enabled, you hear a short alert tone the moment the transmitting radio releases the **PTT** button, indicating the channel is free for you to respond.
-

- 5 Press the **PTT** button to respond.
-

- 6 Once your call ends, press **Emergency Off** button to exit the Emergency mode.
-

Sending an Emergency Alarm with Voice to Follow

This feature allows you to send an Emergency Alarm to a group of radios. Your radio's microphone is automatically activated, allowing you to communicate with the group of radios without pressing the **PTT** button.

This activated microphone state is also known as "hot mic".

Note: Some accessories may not support "hot mic". Check with your dealer or system administrator for more information.

If you press the **PTT** button during the programmed hot mic transmission period, you hear a prohibit tone, indicating that you should release the **PTT** button. The radio ignores the **PTT** press and remains in Emergency mode.

Note: If you press the **PTT** button during hot mic, and continue to press it after the hot mic duration expires, the radio continues to transmit until you release the **PTT** button.

If your radio is set to Silent, it does not display any audio or visual indicators during Emergency mode, or allow any received calls to sound through the radio's

speaker, until the programmed hot mic transmission period is over, and you press the **PTT** button.

If your radio is set to Silent with Voice, it does not display any audio or visual indicators during Emergency mode when you are making the call with hot mic, but allow sound through the radio's speaker when the target radio responds after the programmed hot mic transmission period is over. The indicators only appear when you press the **PTT** button.

Note: If the Emergency Alarm request fails, the radio does not retry to send the request, and enters the hot mic state directly.

1 Press the programmed **Emergency On** button. The display shows **ALRM** and the destination alias. **ALRM** will be displayed till acknowledgement is received. The LED lights up solid green.

2 Once a tone sounds, speak clearly into the microphone.

When hot mic has been enabled, the radio automatically transmits without a **PTT** button press until the hot mic duration expires. While transmitting, the LED lights up solid green.

3 Once the hot mic duration expires, the radio automatically stops transmitting. To transmit again, press the **PTT** button.

Reinitiating an Emergency Mode

Note: This feature is only applicable to the radio sending the Emergency Alarm.

There are two instances where this can happen:

- You change the channel while the radio is in Emergency mode. This exits the Emergency mode. If Emergency Alarm is enabled on this new channel, the radio reinitiates Emergency.
- You press the programmed **Emergency On** button during an Emergency initiation/transmission state. This causes the radio to exit this state, and to reinitiate Emergency.

Exiting Emergency Mode After Sending the Emergency Alarm

Note: This feature is only applicable to the radio sending the Emergency Alarm.

Your radio exits Emergency mode when one of the following occurs:

- Emergency Alarm acknowledgement is received (for **Emergency Alarm** only).
- All retries to send the alarm have been exhausted.
- The **Emergency Off** button is pressed.

Note: If your radio is powered off, it exits the Emergency mode. The radio will not reinitiate the Emergency mode automatically when it is turned on again.

Privacy

If enabled, this feature helps to prevent eavesdropping by unauthorized users on a channel by the use of a software-based scrambling solution. The signaling and user identification portions of a transmission are not scrambled.

Your radio must have privacy enabled on the channel to send a privacy-enabled transmission, although this is not a necessary requirement for receiving a transmission. While on a privacy-enabled channel, the radio is still able to receive clear (unscrambled) transmissions.

Your radio only supports Basic Privacy.

To unscramble a privacy-enabled call or data transmission, your radio must be programmed to

have the same Privacy Key (for Basic Privacy) as the transmitting radio.

If your radio receives a scrambled call that is of a different Privacy Key, or a different Key Value and Key ID, you will hear a garbled transmission (Basic Privacy).

The LED lights up solid green while the radio is transmitting and blinks green rapidly when the radio is receiving an ongoing privacy-enabled transmission.

Note: Some radio models may not offer this Privacy feature. Check with your dealer or system administrator for more information.

Lone Worker

This feature raises an emergency if there is no user activity, such as any radio button press or activation of the channel selector, for a predefined time.

Before raising the emergency, when the inactivity timer expires, the radio warns the user via an audio indicator.

If there is still no acknowledgement by the user before the predefined reminder timer expires, the radio initiates an Emergency Alarm.

Only one of the following Emergency Alarms can be assigned to this feature:

- Emergency Alarm
- Emergency Alarm with Call
- Emergency Alarm with Voice to Follow

The radio remains in the emergency state allowing voice messages to proceed until action is taken. See [Emergency Operation](#) on page 37 on ways to exit Emergency.

Note: This feature is limited to radios with this function enabled. Check with your dealer or system administrator for more information.

Password Lock Features

If enabled, this feature only allows you access your radio if the correct password is entered upon powering up.

Accessing the Radio from Password

- 1 Power up your radio.
You hear a continuous tone.
-
- 2 Push the **Channel Rocker** to enter the first digit of the password.
-

- 3 Press **Side Button 1** to enter each digit of the remaining three digits of the password. When the second digit of the password is entered, your radio ignores any push of the **Channel Rocker**. When the last digit of the four-digit password is entered, your radio automatically checks the validity of the password.

You hear a positive indicator tone for every digit entered.

If the password is correct, your radio proceeds to power up. See [Powering Up the Radio](#) on page 16.

If the password is incorrect, you hear a continuous tone. Repeat steps 1 to 3.

Auto-Range Transponder System (ARTS)

ARTS is an analog-only feature designed to inform you when your radio is out-of-range of other ARTS-equipped radios.

ARTS-equipped radios transmit or receive signals periodically to confirm that they are within range of each other. Your dealer can program your radio to transmit or receive the ARTS signal.

Your radio provides indications of states as follows:

- **First-Time Alert** – A tone sounds.
- **ARTS-in-Range Alert** – A tone sounds, if programmed.
- **ARTS-Out-of-Range Alert** – A tone sounds, the LED rapidly blinks red.

Utilities

Setting the Squelch Level

You can adjust your radio's squelch level to filter out unwanted calls with low signal strength or channels that have a higher than normal background noise.

Normal Squelch is the default. **Tight Squelch** filters out (unwanted) calls and/or background noise; however, calls from remote locations may also be filtered out.

Press the programmed **Squelch** button.

Tone heard ...	Radio operating in ...
Positive Indicator tone	Tight Squelch
Negative Indicator tone	Normal Squelch

Setting the Power Level

You can customize your radio's power setting to high or low for each channel.

PWR H enables communication with radios located at a considerable distance from you. **PWR L** enables communication with radios in closer proximity.

Press the programmed **Power Level** button.

Tone heard ...	Radio transmitting at ...
Positive Indicator tone	Low Power
Negative Indicator tone	High Power

Turning the Voice Operating Transmission (VOX) Feature On or Off

This feature allows you to initiate a hands-free voice activated call on a programmed channel. The radio automatically transmits, for a programmed period, whenever the microphone on the VOX-capable accessory detects voice.

Pressing the **PTT** button during radio operation will disable VOX. To re-enable VOX, do one of the following:

- Turn the radio off and power it on again.
- Change the channel via the **Channel Rocker**.
- Press the programmed **VOX** button to toggle the feature on or off.

Note: Turning this feature on or off is limited to radios with this function enabled. Check with your dealer or system administrator for more information.

Turning the Radio Tones/Alerts On or Off

You can enable and disable all radio tones and alerts (except for the incoming Emergency alert tone) if needed.

Press the programmed **All Tones/Alerts** button.

Tone heard ...	Indication
Positive Indicator tone	All tones and alerts are ON .
Negative Indicator tone	All tones and alerts are OFF .

Checking the Battery Strength

You can check how much battery power you have left.

Press the **On/Off/Information** button to view the battery strength via the LED indicator.

LED indicator	Indication
Blinking Red	Radio has a low battery charge.
Solid Yellow	Radio has a fair battery charge.
Solid Green	Radio has a full battery charge.

See [On/Off/Information Button](#) on page 21 for more information.

Checking the RSSI Values

Your radio shows the Received Signal Strength Indicator (RSSI) icon and signal strength on the display.

Press the **On/Off/Information** button to view the RSSI values on the display.

The number of bars displayed represents the radio signal strength. Four bars indicate the strongest signal. This icon is only displayed while receiving.

See [On/Off/Information Button](#) on page 21 for more information.

Adjusting the Display Brightness

You can adjust radio's display brightness as needed.

Press the programmed **Actions** button and navigate to the item where you can adjust the brightness level. See [Accessing the Programmed Action List](#) on page 20 for more information.

Turning the Voice Announcement On or Off

This feature enables the radio to audibly indicate the current Zone or Channel the user has just assigned, or programmable button press. This audio indicator can be customized per customer requirements.

Press the programmed **Voice Announcement** button.

Tone heard ...	Indication
Positive Indicator tone	All tones and alerts are ON .
Negative Indicator tone	All tones and alerts are OFF .

Authorized Accessories List

Antennas

- UHF, 403 – 425 MHz, 4.5 cm, Stubby Antenna (PMAE4093_)
- UHF, 420 – 445 MHz, 4.5 cm, Stubby Antenna (PMAE4094_)
- UHF, 435 – 470 MHz, 4.5 cm, Stubby Antenna (PMAE4095_)
- VHF, 136 – 144 MHz, 5.0 cm, Stubby Antenna (PMAD4144_)
- VHF, 144 – 156 MHz, 5.0 cm, Stubby Antenna (PMAD4145_)
- VHF, 156 – 174 MHz, 5.0 cm, Stubby Antenna (PMAD4146_)

Batteries

- Lithium-Ion 2300 mAh Battery (PMNN4468_)

Carry Devices

- Nylon Wrist Strap (PMLN6074_)
- Flexible Quick Release Hand Strap (PMLN7076_)
- Heavy-Duty Swivel Belt Clip (PMLN7128_)

- Swivel Carry Holster (PMLN7190_)

Chargers

- Standard Multi-Unit Charger, US/NA Plug (PMLN7101_)
- Standard Single Unit Charger, US/NA Plug (PMLN7109_)
- Micro USB Power Supply, 5 V 1 A, US/NA Plug (25009298001)

Earbuds and Earpieces

- Earbud with In-line Mic/PTT, MagOne (PMLN7156_)
- 2-Wire with Transparent Tube, Black (PMLN7157_)
- 1-Wire Surveillance Earpiece, In-Line Mic and PTT (PMLN7158_)
- Swivel Earpiece, In-line Mic and PTT (PMLN7189_)
- Transparent Acoustic Tube (RLN6242_)
- High Noise Yellow Foam Earpieces (5080384F72)

Miscellaneous Accessories

- Battery Door (PMLN7074_)

Batteries and Chargers Warranty

The Workmanship Warranty

The workmanship warranty guarantees against defects in workmanship under normal use and service.

SL Series Batteries	12 Months
Chargers (Single-Unit and Multi-Unit, Non-Display)	12 Months

The Capacity Warranty

The capacity warranty guarantees 80% of the rated capacity for the warranty duration.

Lithium-Ion (Li-Ion) Batteries	12 Months
--------------------------------	-----------

Limited Warranty

MOTOROLA COMMUNICATION PRODUCTS

I. WHAT THIS WARRANTY COVERS AND FOR HOW LONG:

MOTOROLA SOLUTIONS, INC. (“MOTOROLA”) warrants the MOTOROLA manufactured Communication Products listed below (“Product”) against defects in material and workmanship under normal use and service for a period of time from the date of purchase as scheduled below:

Digital Radios	24 Months
Product Accessories	12 Months

MOTOROLA, at its option, will at no charge either repair the Product (with new or reconditioned parts), replace it (with a new or reconditioned Product), or refund the purchase price of the Product during the warranty period provided it is returned in accordance with the terms of this warranty. Replaced parts or boards are warranted for the balance of the original

applicable warranty period. All replaced parts of Product shall become the property of MOTOROLA.

This express limited warranty is extended by MOTOROLA to the original end user purchaser only and is not assignable or transferable to any other party. This is the complete warranty for the Product manufactured by MOTOROLA. MOTOROLA assumes no obligations or liability for additions or modifications to this warranty unless made in writing and signed by an officer of MOTOROLA.

Unless made in a separate agreement between MOTOROLA and the original end user purchaser, MOTOROLA does not warrant the installation, maintenance or service of the Product.

MOTOROLA cannot be responsible in any way for any ancillary equipment not furnished by MOTOROLA which is attached to or used in connection with the Product, or for operation of the Product with any ancillary equipment, and all such equipment is expressly excluded from this warranty. Because each system which may use the Product is unique, MOTOROLA disclaims liability for range, coverage, or operation of the system as a whole under this warranty.

II. GENERAL PROVISIONS:

This warranty sets forth the full extent of MOTOROLA'S responsibilities regarding the Product. Repair, replacement or refund of the purchase price, at MOTOROLA's option, is the exclusive remedy. THIS WARRANTY IS GIVEN IN LIEU OF ALL OTHER EXPRESS WARRANTIES. IMPLIED WARRANTIES, INCLUDING WITHOUT LIMITATION, IMPLIED WARRANTIES OF MERCHANTABILITY AND FITNESS FOR A PARTICULAR PURPOSE, ARE LIMITED TO THE DURATION OF THIS LIMITED WARRANTY. IN NO EVENT SHALL MOTOROLA BE LIABLE FOR DAMAGES IN EXCESS OF THE PURCHASE PRICE OF THE PRODUCT, FOR ANY LOSS OF USE, LOSS OF TIME, INCONVENIENCE, COMMERCIAL LOSS, LOST PROFITS OR SAVINGS OR OTHER INCIDENTAL, SPECIAL OR CONSEQUENTIAL DAMAGES ARISING OUT OF THE USE OR INABILITY TO USE SUCH PRODUCT, TO THE FULL EXTENT SUCH MAY BE DISCLAIMED BY LAW.

III. STATE LAW RIGHTS:

SOME STATES DO NOT ALLOW THE EXCLUSION OR LIMITATION OF INCIDENTAL OR CONSEQUENTIAL DAMAGES OR LIMITATION ON HOW LONG AN IMPLIED WARRANTY LASTS, SO THE ABOVE LIMITATION OR EXCLUSIONS MAY NOT APPLY.

This warranty gives specific legal rights, and there may be other rights which may vary from state to state.

IV. HOW TO GET WARRANTY SERVICE:

You must provide proof of purchase (bearing the date of purchase and Product item serial number) in order to receive warranty service and, also, deliver or send the Product item, transportation and insurance prepaid, to an authorized warranty service location. Warranty service will be provided by MOTOROLA through one of its authorized warranty service locations. If you first contact the company which sold you the Product (e.g., dealer or communication service provider), it can facilitate your obtaining warranty service. You can also call MOTOROLA at 1-800-927-2744 US/Canada.

V. WHAT THIS WARRANTY DOES NOT COVER:

- 1 Defects or damage resulting from use of the Product in other than its normal and customary manner.
- 2 Defects or damage from misuse, accident, water, or neglect.
- 3 Defects or damage from improper testing, operation, maintenance, installation, alteration, modification, or adjustment.
- 4 Breakage or damage to antennas unless caused directly by defects in material workmanship.
- 5 A Product subjected to unauthorized Product modifications, disassembles or repairs (including, without limitation, the addition to the Product of non-MOTOROLA supplied equipment) which adversely affect performance of the Product or interfere with MOTOROLA's normal warranty inspection and testing of the Product to verify any warranty claim.
- 6 Product which has had the serial number removed or made illegible.
- 7 Rechargeable batteries if:

- any of the seals on the battery enclosure of cells are broken or show evidence of tampering.
 - the damage or defect is caused by charging or using the battery in equipment or service other than the Product for which it is specified.
- 8 Freight costs to the repair depot.
 - 9 A Product which, due to illegal or unauthorized alteration of the software/firmware in the Product, does not function in accordance with MOTOROLA's published specifications or the FCC certification labeling in effect for the Product at the time the Product was initially distributed from MOTOROLA.
 - 10 Scratches or other cosmetic damage to Product surfaces that does not affect the operation of the Product.
 - 11 Normal and customary wear and tear.

VI. PATENT AND SOFTWARE PROVISIONS:

MOTOROLA will defend, at its own expense, any suit brought against the end user purchaser to the extent that it is based on a claim that the Product or parts infringe a United States patent, and MOTOROLA will pay those costs and damages finally awarded against

the end user purchaser in any such suit which are attributable to any such claim, but such defense and payments are conditioned on the following:

- 1 that MOTOROLA will be notified promptly in writing by such purchaser of any notice of such claim,
- 2 that MOTOROLA will have sole control of the defense of such suit and all negotiations for its settlement or compromise, and
- 3 should the Product or parts become, or in MOTOROLA's opinion be likely to become, the subject of a claim of infringement of a United States patent, that such purchaser will permit MOTOROLA, at its option and expense, either to procure for such purchaser the right to continue using the Product or parts or to replace or modify the same so that it becomes non-infringing or to grant such purchaser a credit for the Product or parts as depreciated and accept its return. The depreciation will be an equal amount per year over the lifetime of the Product or parts as established by MOTOROLA.

MOTOROLA will have no liability with respect to any claim of patent infringement which is based upon the combination of the Product or parts furnished

hereunder with software, apparatus or devices not furnished by MOTOROLA, nor will MOTOROLA have any liability for the use of ancillary equipment or software not furnished by MOTOROLA which is attached to or used in connection with the Product. The foregoing states the entire liability of MOTOROLA with respect to infringement of patents by the Product or any parts thereof.

Laws in the United States and other countries preserve for MOTOROLA certain exclusive rights for copyrighted MOTOROLA software such as the exclusive rights to reproduce in copies and distribute copies of such MOTOROLA software. MOTOROLA software may be used in only the Product in which the software was originally embodied and such software in such Product may not be replaced, copied, distributed, modified in any way, or used to produce any derivative thereof. No other use including, without limitation, alteration, modification, reproduction, distribution, or reverse engineering of such MOTOROLA software or exercise of rights in such MOTOROLA software is permitted. No license is granted by implication, estoppel or otherwise under MOTOROLA patent rights or copyrights.

VII. GOVERNING LAW:

This Warranty is governed by the laws of the State of Illinois, U.S.A.



MOTOROLA

Motorola Solutions, Inc.
1303 East Algonquin Road
Schaumburg, Illinois 60196 U.S.A.

MOTOROLA, MOTO, MOTOROLA SOLUTIONS and the Stylized M logo are trademarks or registered trademarks of Motorola Trademark Holdings, LLC and are used under license. All other trademarks are the property of their respective owners.
© 2014 Motorola Solutions, Inc. All rights reserved.
September 2014

www.motorolasolutions.com/slseries



MN000895A01-AA

